

OPERATION
SAFETY
SERVICE
WARRANTY
CONTACT
SPECIFICATIONS
TROUBLESHOOTING

Bear Power Pro Series

Instruction Manual

READ AND SAVE THESE INSTRUCTIONS



THANK YOU FOR PURCHASING A B-AIR PRODUCT.

Before Grooming

Be careful not to blow air into the animal's face, ears or nose. Use the cone nozzle to blow out dirt from the undercoat and separate matted hair

After Bathing

Towel-dry the animal to remove excess water. Use the cone nozzle to blow off moisture working out from the skin. Switch to one of the other attachments to dry more sensitive areas.

Operation / Use

- Plug the flexible hose to the front cap connector
- Plug in the power cord and switch power on
- Adjust the variable wind speed switch knob and select the desired setting according to your needs
- Turn the variable wind speed switch knob back to minimum and turn off the power switch after usage
- Unplug the dryer from the power source and unplug the hose and nozzle when you are finished using the dryer

Power Requirements

Cords

Use a single outlet that is at least 20 amps and has a ground wire. Use the unit with a correct outlet and do not share the same outlet with other appliances.

Use 3 pronged adapters that are UL and CE approved with Ground Fault Circuit Interrupter (G.F.C.I). Do not use power cords that show any sign of wear or damage. Cords are not covered by warranty.

Safety

- Do not immerse the unit in water. Exposure to water will result in electric shock
- Do not alter or remove the grounding plug. Do not use the unit if it cannot be properly grounded
- Do not use the unit if the power cord is frayed or shows any sign of wear
- Do not place the unit in standing or running water. Exposure to water will result in electric shock
- Do not let the air intakes of the unit get blocked or clogged. Overheating of the equipment may occur and cause fire or an electrical hazard
- Never use the unit without a filter in place
- Do not leave the unit unattended when in use and / or turned on
- Individuals with pacemakers should not use this machine
- Always hold the nozzle and hose firmly when the unit is in operation

Maintenance

- Clean filters regularly (every 2 months) by washing or air blowing. Be sure not to use the unit without a filter in place
- Keep the surface of the unit clean and dry
- Refer to the guide in this owner's manual to replace motor brushes. Replace brushes every 4-6 months

Limited Warranty

Proof of purchase is required on all warranty claims.

Warranty covers against defects in material and craftsmanship used under normal intended use to original purchaser for a term of (2) two years from the original date of purchase including parts, labor and 1 way shipping. Housing is covered for a term of (5) five years from the date of the original purchase.

Important!

Warranty does not cover signs of misuse including, but not limited to rough handling, abuse, tampering, improper voltage use and unauthorized maintenance and repairs.

Specifications:

VOLTS	115 V
CYCLE	60 Hz
FPM	55000
AMPS	14
CFM	445
WEIGHT NET/SHIP	16/20
UNITSIZE(L x W x H)	19" x 6" x 10"
UNITSIZE BOX (L x W x H)	23" x 9" x 15"
HOSE LENGTH	5FT
MOTOR	2.1HP
NOISE LEVEL	76-84
SPEEDS	VAR IABLE

Motor Brush Replacement steps.

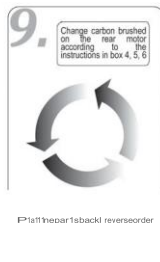
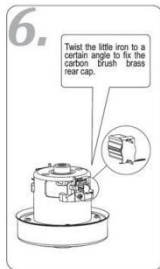
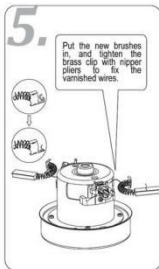
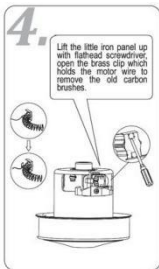
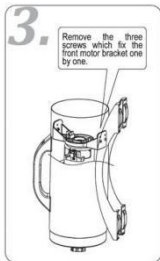
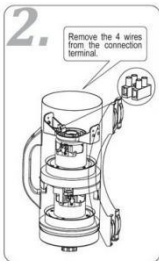

Bear Pro Series BPS-II

PART LIST

Item No.	Part Name	Quantity	
TD-90056	B-air Rear Cap Knob	1	
TD-90005	Rear Cap	1	
TD-90007	Foam Filter	1	
TD-90057	B-air Double Motor Dryer Handle	1	
TD-90009	M4x12 Screw and Nut	9	
TD-90013	PA3x1Q Self-tapping Screw	4	
TD-90058	B-air Long Housing-PMS213	1	
	B-air Long Housing-PMS265		
	B-air Long Housing-PMS311		
	8-air Long Housing-PMS375		
TD-90059	8-air Long Housing Base	1	
TD-90060	Long Rubber Foot(left)	2	
TD-90061	Long Rubber Foot(right)	2	
TD-90015	M5x6 Screw	16	
TD-90016	Vibration Absorber Ring	1	
TD-90017	Motor A	2	
TD-90018	Rubber Washer	2	
TD-90019	Carbon Brush	2	
TD-90046	Dual Motor Fixture Bracket	1	
TD-90045	Middle Rubber Ring	1	
TD-90020	Single Motor Fixture Bracket	1	
TD-90044	Connection Terminal	1	
TD-90023	PA3x16 Self-tapping Screw	7	
TD-90021	Rubber Seal	1	
TD-90025	PG-9 Waterproof Cable Connector	1	
TD-90026	Power Cable	1	
TD-90028	Wind Speed Knob	1	
TD-90030	Power Switch	1	
TD-90042	PCB-B(220V)	1	
	PCB-B(110V)		
TD-90043	Front Cap -8	1	
TD-90031	Front Cap D52 Hose Connector	1	
TD-90032	052 Nylon Clip	1	
TD-90062	12' Hard Pipe	1	
TD-90034	D52 Hose Connector	1	
TD-90063	Rubber Flat Narrow Nozzle	1	
TD-90064	Rubber Round Nozzle	1	
TD-90065	M4x8 screw and nut	1	
TD-90066	Hightemperature resistant silicone wire	-A Brown,0.75mm'x200mm	1
		-B Blue, 0.75mm'x200mm	
		-C BIUM I, 0.75mrrfx360mm	
		-D Blue, 0.75mrrfx360mm	

Structure Chart

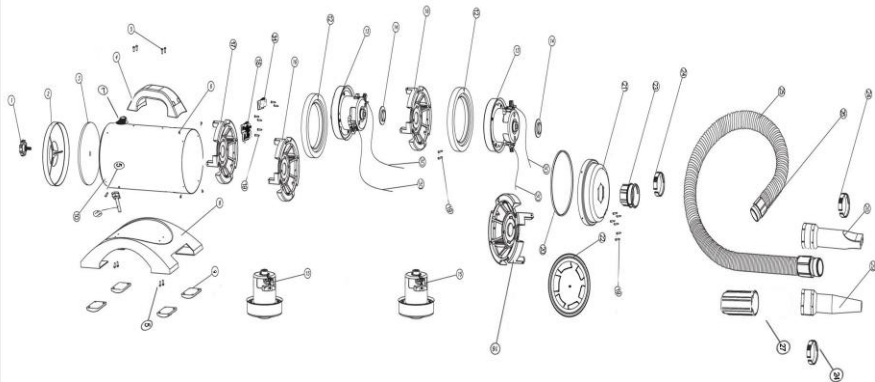

Remarks: The chart is only for repair parts order references, the real structure should be subject to current available product, since we may make modifications without notice in formal written form.

WARRANTY REGISTRATION

Please complete and mail or fax your product warranty registration card. For multiple units, please put 1st serial numbers on a separate

THIS WARRANTY CARD AND YOUR BILL OF SALE MUST BE PRESENTED FOR WARRANTY SERVICE

Your Company Name _____

Contact Name _____ Title _____

Address _____

City _____ State _____ Zip _____

_____ Phone _____ Fax _____

_____ E-mail _____

Bear Pro Series BPS-II

Serial Number _____ Date of Purchase ____/____/____

Purchased From _____

Additional Comments/Suggestions _____

B-Air

550 South Ayon Ave. Azusa, CA 91702

1-877-800-2247 (BAIR)

Fax: (626) 385-3307

Email: info@b-air.com

Web site: www.b-air.com

PLACE
STAMP
HERE



550 South Ayon Ave
Azusa, CA 91702